

MODEL	BF-P1500-60
Standby Power (60Hz)	1200KW/1500KVA
Prime Power (60Hz)	1090KW/1364KVA

Standard Features

General Features:

Engine (Perkins 4012-46TWG3A)
 Radiator 50°C max, fans are driven by belt, with safety guard
 24V charge alternator
 Alternator: single bearing alternator IP23, insulation class H/H
 Absorber
 Dry type air filter, fuel filter, oil filter
 Main line circuit breaker
 Standard control panel
 batteries, rack and cable
 Ripple flex exhaust pipe, exhaust siphone, flange, muffler
 User manual



PHOTO FOR REFERENCE ONLY

Generator Ratings

Voltage	HZ	Phase	P.F (COS ϕ)	Standby Amps	Standby Ratings (KW/KVA)	Prime Ratings (KW/KVA)
480/277	60	3	0.8	1804.3	1200/1500	1090/1364
460/266	60	3	0.8	1882.7	1200/1500	1090/1364
440/254	60	3	0.8	1968.3	1200/1500	1090/1364
416/240	60	3	0.8	2081.9	1200/1500	1090/1364

Prime Power (PRP): Prime power is available for an unlimited number of annual hours in variable load application, in accordance with GB/T2820-97 (eqvISO8528) ; A 10% overload capability is available for a period of 1 hour within a 12-hour period of operation.

Standby Power Rating (ESP): The standby power rating is applicable for supplying emergency power for the duration of a utility power interruption. No overload, utility parallel or negotiated outage operation capability is available at this rating.

Sales Promises

Baifa Power provides a full line of brand new and high quality products. Each and every unit is strictly factory tested.

Warranty is according to our standard conditions: 12 months or 1,000 running hours, subject to the earlier one.

Service and parts are available from Baifa Power or distributors in your location.

ENGINE DATA

Manufacturer / Model:	Perkins 4012-46TWG3A, 4-cycle
Air Intake System:	Turbocharged, water to air charge cooled
Fuel Injection System:	Direct Injection
Cylinder Arrangement:	12 in V type
Displacement:	45.842L
Bore and Stroke:	160×190 (mm)
Compression Ratio:	13
Rated RPM:	1800rpm
Max. Standby Power at Rated RPM:	1321KW/1797HP
Governor Type:	Electronic

Exhaust System

Exhaust Gas Flow(after turbo):	240m ³ /min
Exhaust Temperature:	482°C
Max Back Pressure:	5kPa

Air Intake System

Max Intake Restriction:	4kPa
Consumption:	117m ³ /min
Air Flow:	1855m ³ /min

Fuel System

100%(Prime Power) Load:	218g/KWh
75%(Prime Power) Load:	N/A
50%(Prime Power) Load:	N/A
100%(Prime Power) Load:	290.3 L/H

Oil System

Total Engine Oil Capacity:	177L
Engine Oil Tank Capacity:	157.5L
Min Oil Pressure at Rated RPM:	340kPa

Cooling System

Total Coolant Capacity:	201L
Thermostat:	71- 85 °C
Max top tank Temperature:	101°C

ALTERNATOR SPECIFICATION**GENERAL DATA**

Compliance with GB755,BS5000,VDE0530,NEMA MG1-22,IEC-34,CSA C22-100and AS1359 standards.

Alternator Data

Number of Phase:	3
Connecting Type:	3 Phase and 4 Wires, "Y" type connecting
Number of Bearing:	1
Power Factor:	0.8
Protection Grade:	IP23
Altitude:	≤1000m
Exciter Type:	Brushless, self-exciting
Insulation Class, Temperature Rise:	H/H
Telephone Influence Factor (TIF):	<50
THF:	<2%
Alternator Capacity:	1482KVA
Alternator Efficiencies:	96.3%

GENERATING SET DATA

Voltage Regulation:	≥±5%
Voltage Regulation, Stead State:	≤±1%
Sudden Voltage Warp (100% Sudden Reduce):	≤+25%
Sudden Voltage Warp (Sudden Increase):	≤-20%
Voltage Stable Time (100% Sudden Reduce):	≤6S
Voltage Stable Time (Sudden Increase)	≤6S
Frequency Regulation, Stead State:	≤5%
Frequency Waving:	≤1%
Sudden Frequency Warp (100% Sudden Reduce):	≤+12%
Sudden Frequency Warp (Sudden Increase):	≤-10%
Frequency Recovery Time (100% Sudden Reduce):	≤5S
Frequency Recovery Time (Sudden Increase):	≤5S

Standard Features

- ◇ Baifa Standard Auto Control System
- ◇ Oil Drain Valve
- ◇ Documents
- ◇ Starting batteries (Maintenance-Free & Watering-Free) with connective wires
- ◇ Exhaust System(including until muffler)
- ◇ Base Fuel Tank

Options

- ◇ Daily Fuel Tank
- ◇ Battery Charger
- ◇ Engine Heater
- ◇ Alternator Heater
- ◇ Water Separator
- ◇ Remote Control Panel
- ◇ Rainproof Type
- ◇ Soundproof Type
- ◇ Trailer Type
- ◇ Automatic Transfer Switch
- ◇ Switch box
- ◇ Spare Parts

Dimension & Weight

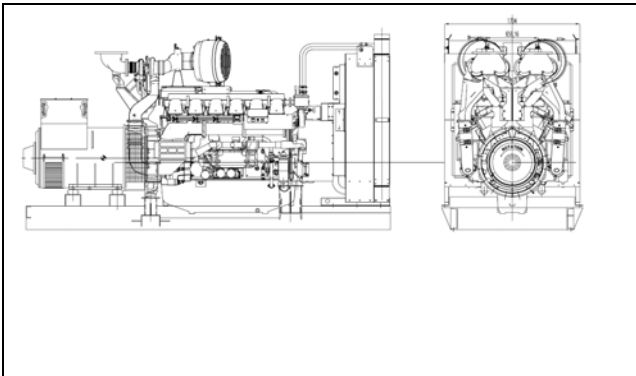

Open Type

Overall Size: 4700×1780×2400 mm
Weight: 9700kg

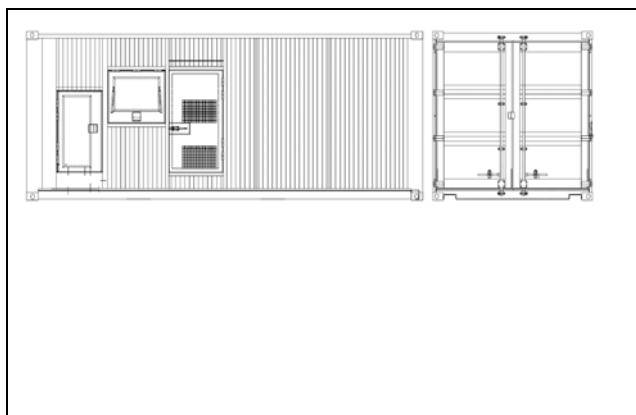

Soundproof Type (ISO 20'ft GP)

Overall Size: 6058×2438×2896 mm
Weight: 14700kg

Auto Module Control Panel



Auto Module Control Panel is the configuration for nobody on duty controlling generators. This kind of panel adopts auto module control system, with large LCD display to show the menu.

Features: MRS10-can receive remote output signal from ATS and realize auto start and stop of generators.

MRS16-can realize all functions of MRS10, add RS232 interface which can communicate with PC to realize remote operation.

AMF25-Auto Mains Failure controller, can realize all functions of MRS16, furthermore can detect ATS and control directly.

Auto Parallel Control Panel



Automatic Parallel Control Panel This new automatic parallel system adopts intelligent modules, inserted and folded installed, no need the peripheral relay and logic circuit. The main switch adopts electronic breaker or frame breaker, combined together with the generator, which is very reliable. One generator, one panel. The panel can be used both for singly and parallel. It is only need to parallel generator with such panel when the capability needs to be enlarged in the future.